

OWNER'S MANUAL



Thank you very much for purchasing **BMB** product.

Before using this product, please carefully read the user manual, in order to facilitate correct operation. After reading through it, please properly keep it for future reference.







ATTENTIONS ON SAFETY

Based on safety, before correct use of this product, please carefully read through this user manual again. After reading through it, please properly keep it for future reference.

<ATTENTIONS ON SAFETY> A variety of icons and signs are provided to prevent damages and property losses to you or others. The mark and significance of icons are provided below. Please read and understand them.

- | | | |
|---|----------------|--|
|  | WARNING | Neglect of this mark and misuse of this product may cause serious human injury or even death. |
|  | NOTE | Neglect of this mark and misuse of this product may cause product damage or even human injury. |

EXAMPLES OF ICONS

- | | | |
|---|---|--|
|  |  | The mark provides attentions/warnings. The middle content in the icon provides specific attention. (The description in the left figure means to guard against electric shock). |
|  |  | The mark shows prohibited acts. The middle content in the icon provides specific instructions (The description in the left figure means to prohibit disassembly). |
|  |  | The mark provides compulsive behaviors or instructions. The middle content in the icon provides specific instructions (The description in the left figure shows pulling the power plug out of the socket). |

SPECIFICATION

Dimensions (mm): 401.7 (W) × 68.1 (H) × 329.7 (D)

Weight: 0.48 kg/piece

Annex: Owner's Manual (This book) × 1

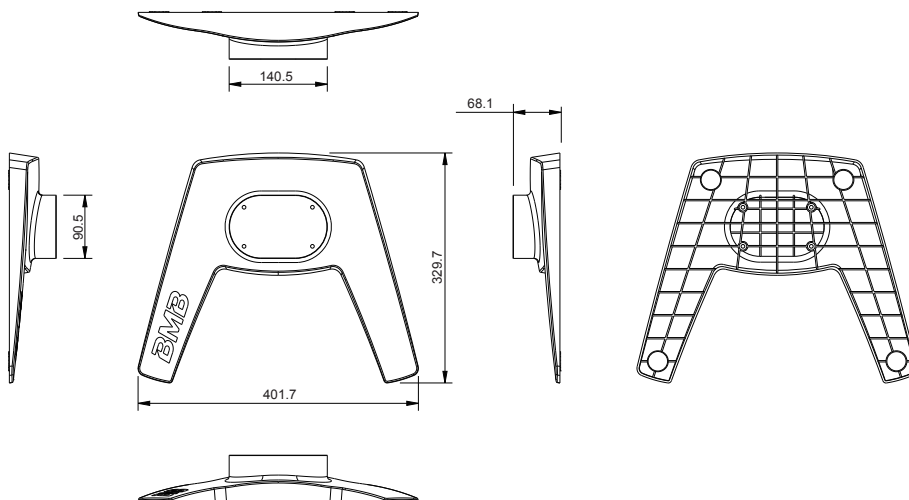

INSTALLATION

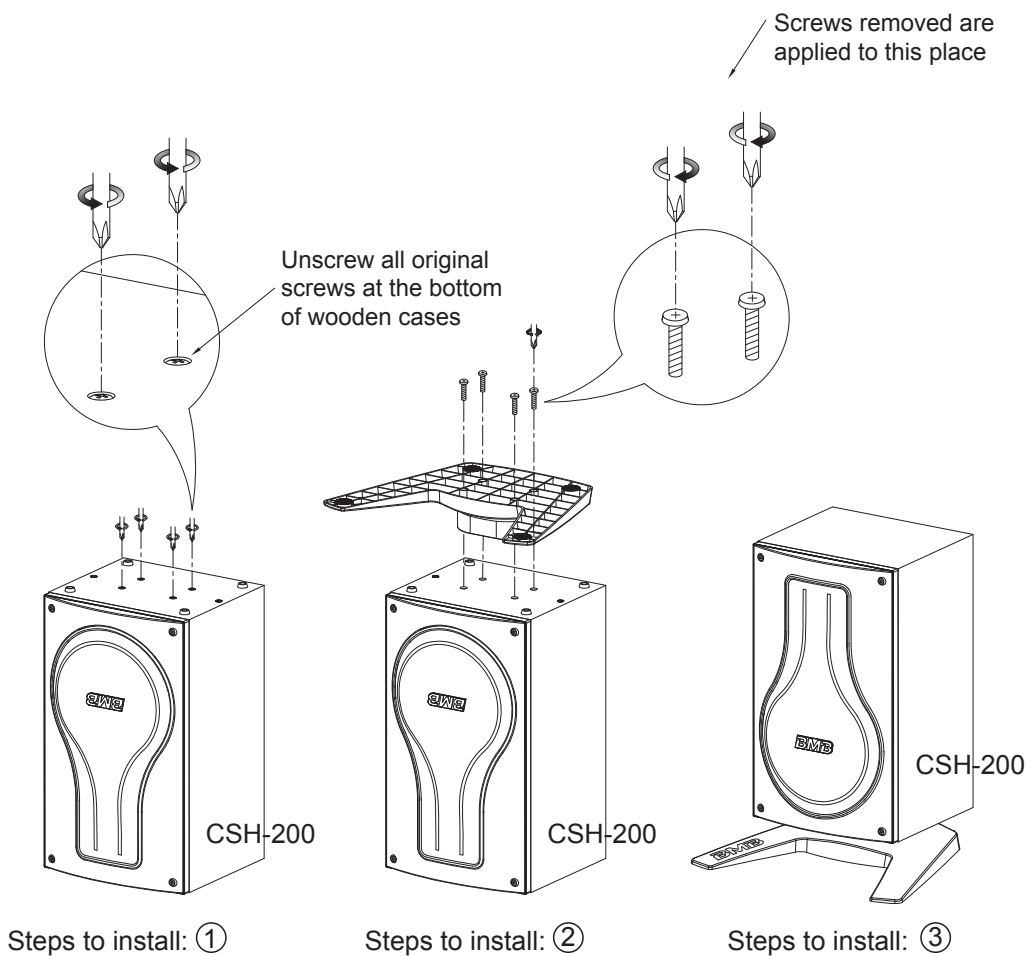

- Due to product improvement, all above specifications and appearances are subject to change without notice.
- The copyright of this manual belongs to BMB International Corp.

BMB International Corp.

<http://www.bmb.com>