

OWNER'S MANUAL

THANK YOU VERY MUCH FOR PURCHASING THIS **BMB** SPEAKERS SYSTEM.

READ THE INSTRUCTION MANUAL CAREFULLY BEFORE USING THIS SPEAKERS SYSTEM SO THAT YOU CAN OPERATE IT PROPERLY. AFTER YOU HAVE FINISHED, PUT THIS MANUAL AWAY IN A SAFE PLACE FOR FUTURE REFERENCE.

MATTERS OF SAFETY FIRST

Based on security, before the correct use of this product, please carefully read through the instructions again. After reading, please keep it for future reference.

(< MATTERS OF SAFETY FIRST > is to prevent harm to you or others, property loss, to a variety of pattern identification. The identification and significance of pattern, please fully understand before you continue reading.

 **WARNING** If ignore this logo, misuse, may cause serious injury or even death.

 **CAUTION** If ignore this logo, misuse, may cause damage of the goods or injuries.

PATTERN REPRESENTATION OF CASES



△ Mark is told to pay attention to the content (with a warning). Pattern of the intermediate drawing attention to concrete content(this description refers to the attention of electric shock).



⊘ Mark is to inform the prohibited acts. Pattern of intermediate describe specific content prohibited. (left picture it means no decomposition).



● Mark is inform compulsive behavior, content. Pattern of the intermediate drawing indicates the specific content (this description refers to the power plug from the socket).

WARNING

■ FAULT STATE DO NOT CONTINUE TO USE



- In case, continue to use the emergence of smoke, odor, noise and other abnormal condition, will cause fire, electric shock, amplifier fault. Immediately turn off the amplifier, must pull out the power plug from the socket. Confirmation until stopped smoking, to rely on sales shop.

■ DO NOT TRANSFORMATION



- Don't alter or decomposition of the products. May result in fire, electric shock.

■ DON NOT PUT IN THE POSITION OF WATER



- This product can not be water, do not get wet. Water, wet may result in fire, electric shock. In the rainy day, snow day, coast, water use should be paid special attention to the.

■ CANNOT BE WATER CONTAINERS ARE PLACED



- Don't use a vase, potted plant, glass, cosmetics, pharmaceuticals, container with water and small metal items in the product. The water spill, into the inside of the machine will cause fire, electric shock.



- In case of the machine, water, immediately turn off the amplifier, unplug the power plug from the socket, and then contact the sales shop. Continue to use, will cause fire, electric shock.





■ DON NOT BE FOREIGN BODY INTO THE INTERIOR





- In case, foreign body into the machine, turn off the amplifier power, unplug the power plug from the socket, and then contact the sales shop. Continue to use, will cause fire, electric shock.

CAUTION

■ INSTALLING

-  ● Can not be placed in the shaking of the table upper unstable place. Falling down, falling down can lead to injuries.
-  ● Move the product, do not hand grasping the iron net, the speaker unit. May cause injury.
-  ● Moving the product, turn off the amplifier, unplug the power plug from the socket, remove the speaker cable and mobile. Or will lead to cable damage, cause fire, electric shock.
-  ● The product is placed on TV, audio equipment, do not move the product. Articles collapse cause injury.
-  ● This product can not be placed over 10kg weight and ratio of large size items. The imbalance will make the goods fall, fall and hurt.





■ CAN NOT SET IN THE FOLLOWING AREAS

-  ● Can not be placed in the food processing machine, humidifier, steam soot place. May result in fire, electric shock.
-  ● Can not be placed in damp, dusty places. May result in fire, electric shock.

■ ON CONNECTION

-  ● The machine and other audio equipment, television sets and other machine connection, please read carefully the instructions of each machine, Switch off the power supply, follow the instructions.

■ NOTE AT WHEN USING

-  ● Switch on the power set the volume to a minimum. All of a sudden loud noise can cause hearing impairment.
-  ● Don't use long time voice distortion under the state. The speaker fever will cause fire
-  ● Please don't sit on or suspended in the loudspeaker. Special attention should be paid to the child. Collapse, damage can result in injury.
-  ● Cash card, disk with magnetic products do not close. The speaker magnetic will affect the products, the use of data Disappear.

BEFORE USE

Operating Precautions

- The maximum input power of these speakers is 500 W (at peak). Higher levels of input power may cause damage to the speaker system and so take every precaution to keep the power down to the specification.
- Even if an amplifier with a maximum output power of less than 500 W is employed, do not use the speakers with the volume turned up too high or the sound distorted. This may damage the speakers.
- Make sure that the amplifier's power switch is at the OFF position when connecting the speakers to the amplifier.
- Make sure that the amplifier's volume control is turned down to its lowest setting when the amplifier's power switch is set to the ON position.

CONNECT TO AMPLIFIER

- Make sure that you set the power switch on the amplifier to the OFF position when connecting the speakers to the amplifier.
- Align the (-) and (+) polarities of the speakers with the (-) and (+) polarities of the left (L) and right (R) channels of amplifier, and connect the speakers to the speaker terminals on the amplifier. (Please refer to the below drawing.)

* If the polarities of the left and right speakers are not aligned properly, the quality of the reproduced sound, the ambience and the feeling of direction will all be markedly impaired.

* When making the connections, take every precaution to prevent the speaker cords' central cores from being shorted.

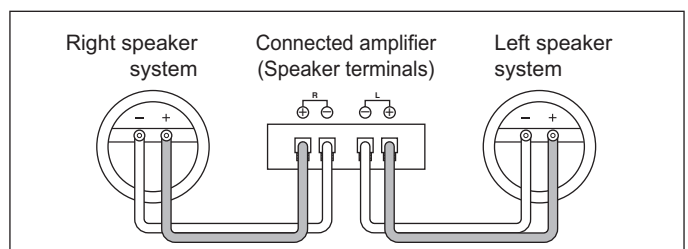

INSTALLING THE SPEAKERS

- Avoid installing the speakers in a location exposed to direct sunlight and high levels of humidity. Avoid also locations in the vicinity of stoves and other sources of heat.
- With a speaker system, the sound which is heard varies greatly according to the installation location. Bear in mind the following points in order to derive the most enjoyment from music.
 - a) Install the speaker at the upper position than your ears level when you listen to the sound under normal listening conditions.
 - b) The best distance between the speakers is approx. 2 to 5 m.
 - c) The bass sounds fuller if the speakers are installed on a solid and stable stand or shelf, or if they are placed against a wall. The bass sound will lose its impact if objects which do not reflect the bass well enough are placed in front of the speakers.
- If you plan to hang your speakers from the ceiling, contact a professional installer.
- This speaker system is not magnetically shielded. However, depending on the installation location, color distortion may occur if the speaker system is installed extremely close to the screen of a television set. If this happens, turn off the television, then turn it on again after 15 to 30 minutes. If the problem persists, place the speaker system away from the television set.

Caution:

If you want to suspend the CSV-480 from the ceiling, use adequate mounting hardware that can bear the load. In addition, be sure to secure the mounting hardware onto a place of high-tensile strength using screws appropriate to the ceiling materials.

SPEAKER MAINTENANCE

- Wipe off dust or dirt with soft cloth.
- If the speaker is very dirty, wipe it with soft cloth dipped with neutral solvent diluted with 5~6 times of water, and then wipe it with dry cloth. Do not use diluter, gasoline, detergent or other chemical solvents on or near the speaker. Otherwise, its surface may be damaged. In addition, do not use insecticide or other spraying agent near the speaker.

TONE CONTROL

- This speaker system offers a slide switch that gives you two tone choices: TREBLE and FLAT. The TREBLE position is intended for listening in a large room; the FLAT position is suitable for a small room. This switch is located on the rear face of each speaker.

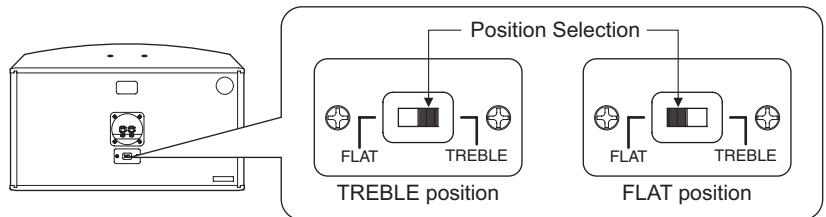

PROPERLY CONNECT THE SPEAKER TO YOUR POWER AMPLIFIER (for example, 4 speakers)

- Configure and wire the speakers so that the combined impedance falls within 6 to 32 Ω .

Note:

The specification allows the combined impedance ranging 4 to 32 Ω , however, 4 Ω configuration is not recommended; avoid it whenever possible.

Allowable Examples

Allowable Example 1

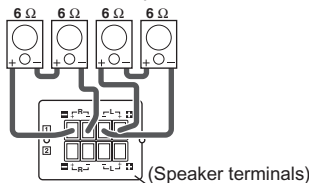

OK: Combined impedance is 12 Ω

Allowable Example 2

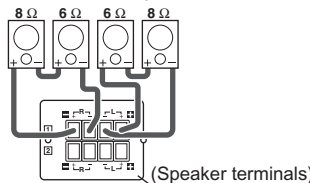

OK: Combined impedance is 14 Ω

Allowable Example 3

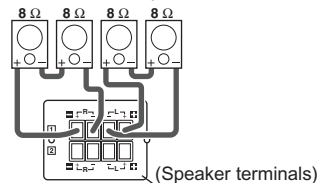

OK: Combined impedance is 16 Ω

Not-allowable Examples

Not-allowable Example 1

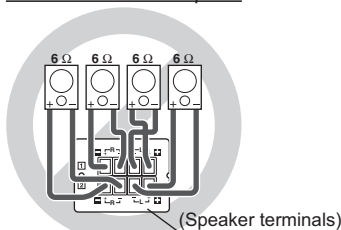

NG: Combined impedance is 3 Ω

Not-allowable Example 2

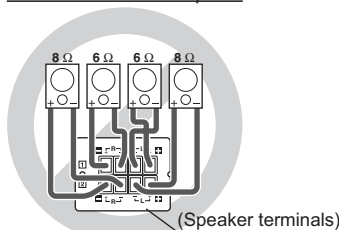

NG: Combined impedance is 3.4 Ω

Not-allowable Example 3

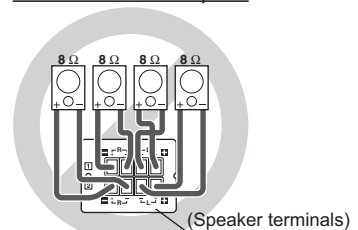

NG: Combined impedance is 4 Ω

SPECIFICATION

System	3 Ways 3 Speaker
Woofer Unit	25cm Paper Cone Type × 1unit
Squawker Unit8cm Paper Cone Type × 1unit
Tweeter Unit8cm Paper Cone Type × 1unit
Max Input Power	500 W
Rating Input Power	250 W
Sound pressure Level	88 dB/W/m
Frequency response	40 Hz - 20 kHz
Impedance	8 Ω
Dimensions (mm)	560 (W) x 292 (H) x 297 (D)
Weight	11.5 kg
Accessories	Owner's manual x 1
.....	Registration card x 1

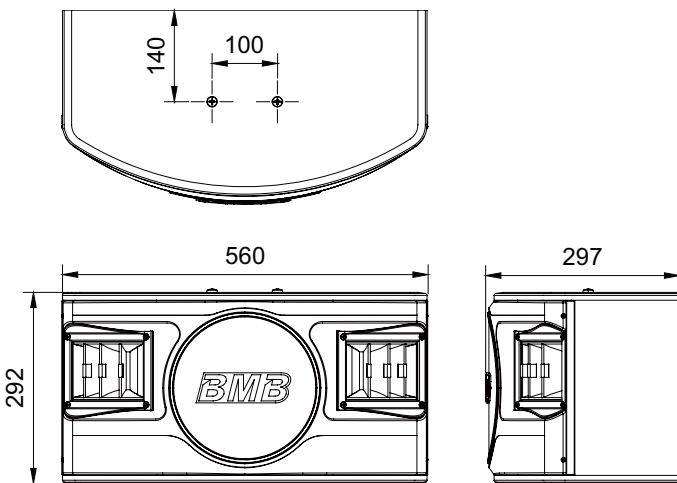

STANDARD FEATURES

FREQUENCY RESPONSE

■ TREBLE Position (Straight ahead from the tweeter)

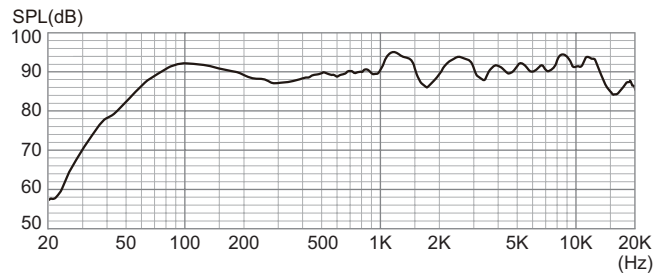

■ FLAT Position (Straight ahead from the tweeter)

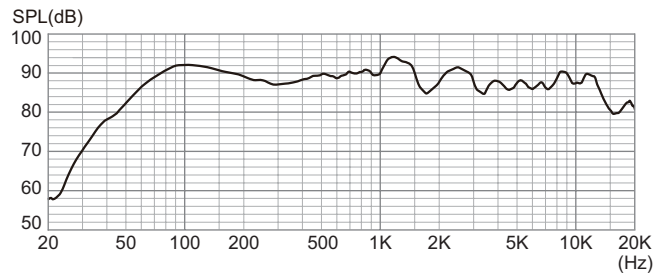

IMPEDANCE CURVE

■ TREBLE Position

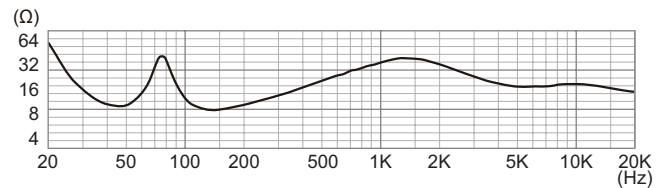

■ FLAT Position

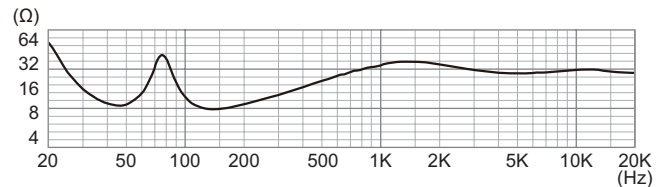

- Due to product improvement, all above specifications and appearances are subject to change without notice.
- The copyright of this manual belongs to BMB International Corp.

BMB International Corp.

<http://www.bmb.com>

201608